

Specifications

Model No	BAK-010A
Standard	UL1472
Rated Voltage	120V~
Rated Frequency	/
Rated Power	300W
Load Range	Incandescent lamp 15W-500W
	LED lamp 5W-300W
	Halogen lamp 15W-500W
	Low voltage halogen lamp with electronic transformer 15W-500W
	Low voltage halogen lamp with iron core transformer 15W-500W
	CFL -- fewer than 5pcs 15W-500W
	Electric resistive heat 15W-500W
Switch times	≥20000 times
Power supply	Neutral & Live Wire
Installation method	In-Wall
Operating Environment	Temperature: 0°C - 40°C
	Humidity: 8% R.H. - 90% R.H.
Size	4.13in×1.69in×1.77in (L×W×H)
Application	Indoor
Function	1. Can turn the light on,off and with dimming function. 2. Automatic memory function with power off. 3. With functional indicator light. 4. Can connected with an external switch to control the light on/off. 5. Over temperature protection.

Product Summary

- Input voltage: Wide voltage design, adaptive AC85-265V operating voltage.
- Power supply design: isolated power supply design, can be used with dimming power supply.
- Dimming: 0-10V voltage output, 1-100% dimming range.
- LED dimming indicator: 5 LED dimming progress indicators, through the indicator can visually view the dimming brightness percentage.
- Zero crossing detection: The product supports zero crossing detection circuit to extend the service life of the product.
- Dual control: Support dual control function, this product supports an external 3way switch.
- Installation: Designed according to the size of single-channel American standard switch, easy to install.
- Certificate: With ETL certification.

Features

- Push button switch turn the lights ON/OFF
- Use as single pole or 3-way
- Compatible with most switch panels

Dimensions

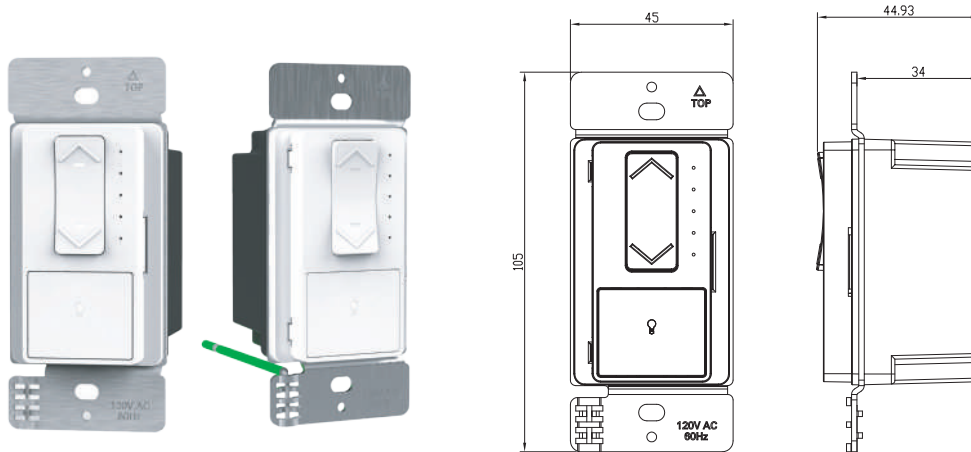

Installation

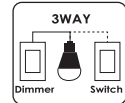
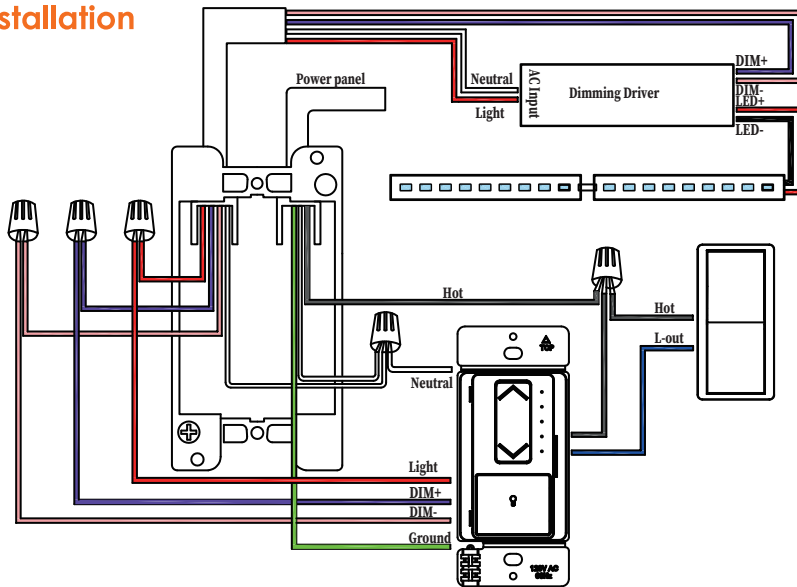

- Turn off power at circuit breaker or fuse and test that power is off before wiring.
- Install according to the wiring diagram above.
- Carefully position all wires inside the wall-box, leaving enough space to insert the dimmer. Secure the dimmer with the provided mounting screws.

This product is a 0-10V voltage output single-channel dual-control dimmer(with neutral).

It can adjust the 0-10V output signal through the button panel to control the 0-10V dimmable driver power supply for dimming control.

Suitable for commercial and household use, easy to install, paired with American standard switch socket junction boxes.

⚠ WARNING:

Turn the POWER OFF at the circuit breaker, carefully read and understand these instructions before installation. This device is intended for installation in accordance with the National Electric Code and local regulations. A qualified electrician is recommended for performing installation. Make sure to turn off the circuit breaker or fuse(s) and make sure power is off before wiring the device.