

Project : \_\_\_\_\_  
 Type : \_\_\_\_\_  
 Drawn by : \_\_\_\_\_  
 Catalogue No. : \_\_\_\_\_  
 Date : \_\_\_\_\_

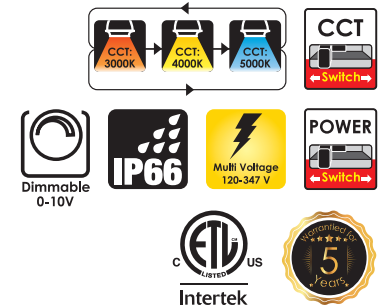

200W



250W



300W



500W

## Specifications

Model No		□ ISL-FL02-A-200W	□ ISL-FL02-A-250W	□ ISL-FL02-A-300W	□ ISL-FL03-A-500W
General	Watts	200W-150W-100W ADJ	250W-200W-150W ADJ	300W-240W-200W ADJ	500W-400W-300W ADJ
	CCT	3000K-4000K-5000K ADJ	3000K-4000K-5000K ADJ	3000K-4000K-5000K ADJ	3000K-4000K-5000K ADJ
	Lumen	15,000 - 30,000LM	22,500 - 36,000LM	30,000 - 45,000LM	45,000 - 75,000LM
	Volts	120-347Vac	120-347Vac	120-347Vac	120-347Vac
	CRI	>80	>80	>80	>80
	Beam Angel	120°	120°	120°	120°
	Hours Rated	60 000 hours	60 000 hours	60 000 hours	60 000 hours
Electrical	Operating Frequency	50-60Hz	50-60Hz	50-60Hz	50-60Hz
	Power Factor	>0.9	>0.9	>0.9	>0.9
	THD	20%	20%	20%	20%
	Dimming	0-10V	0-10V	0-10V	0-10V
Physical	Dimension(L*W*H)	412*366*63mm	486*406*69mm	486*406*69mm	550*589*56mm
	LED Type	SMD2835	SMD2835	SMD2835	SMD2835
	LED Quantity	960PCS	1200PCS	1440PCS	2400PCS
	Housing Color	Black	Black	Black	Black
	Housing Material	Aluminum	Aluminum	Aluminum	Aluminum
	Cover Material	Tempered Glass	Tempered Glass	Tempered Glass	Tempered Glass
	Net Weight	5.25KGS	7.43KGS	7.43KGS	9.75KGS
	IK Rating	IK08	IK08	IK08	IK08
Additional Information	Operating Temperature	-30°C To +50°C	-30°C To +50°C	-30°C To +50°C	-30°C To +50°C
	Operating Humidity	20%-90%	20%-90%	20%-90%	20%-90%
	Storage Temperature	-40°C To +80°C	-40°C To +80°C	-40°C To +80°C	-40°C To +80°C
	Storage Humidity	10%-90%	10%-90%	10%-90%	10%-90%
	Warranty	5 Years	5 Years	5 Years	5 Years
Compliance	Safety Listing	cETL-Listed	cETL-Listed	cETL-Listed	cETL-Listed
	Waterproof Rating	IP66	IP66	IP66	IP66

### Features & Specifications

#### Construction

- Die-casting technology by ADC12 ensures outstanding heat dissipation
- High light transmittance & anti-aging 4mm tempered glass cover
- Waterproof rating of IP66 making it suitable for outdoor use
- The rotatable design can make the LED Flood light easier to adjust and get the best lighting angle.
- Breather valve balances the internal and external pressure and humidity

#### Mounting

- Bracket Mounting, Pole Mounting

#### Performance Data

- Available in 3000K/4000K/5000 K selectable color temperature
- 80+ CRI
- Electrical ratings: 120-347 Vac
- Estimated life of over 60 000 hours to L70
- 0-10 V dimming driver. Dimming cables included with this luminaire
- 6kV surge protection (standard)
- Operating temperature: -30°C to 50°C

#### Compliances

- ETLus certified for wet locations
- IP66

### Dimensions & Weights

Model	Length in.(mm)	Width in.(mm)	Height in.(mm)	Net weight (KGS)
200W	16.22(412)	14.41(366)	2.48(63)	5.25
250/300W	19.13(486)	15.98(406)	2.72(69)	7.43
500W	23.19(589)	21.65(550)	2.20(56)	9.38

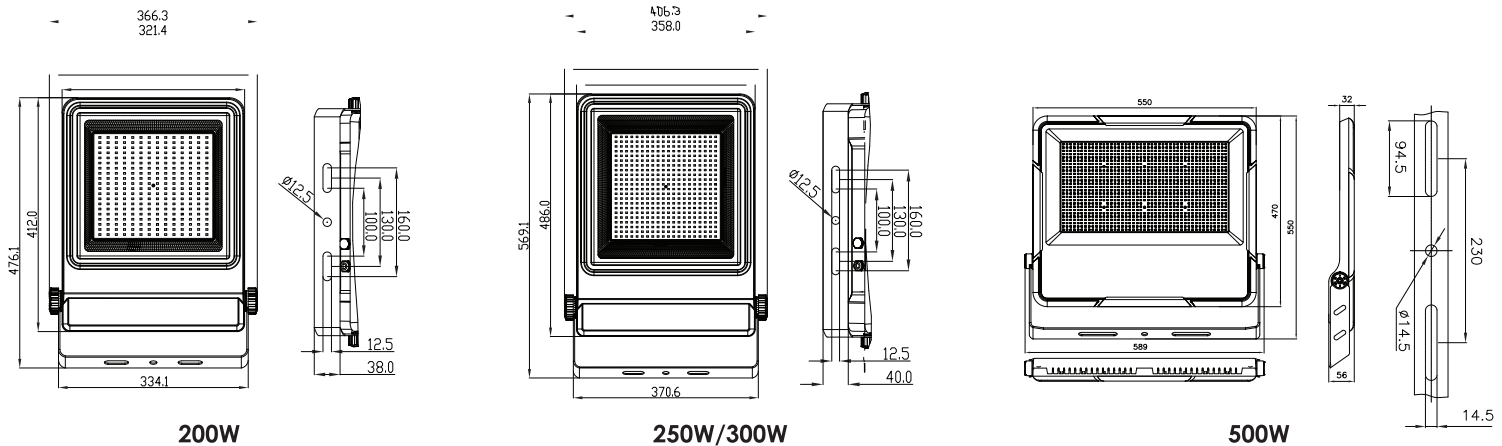

### Product Details

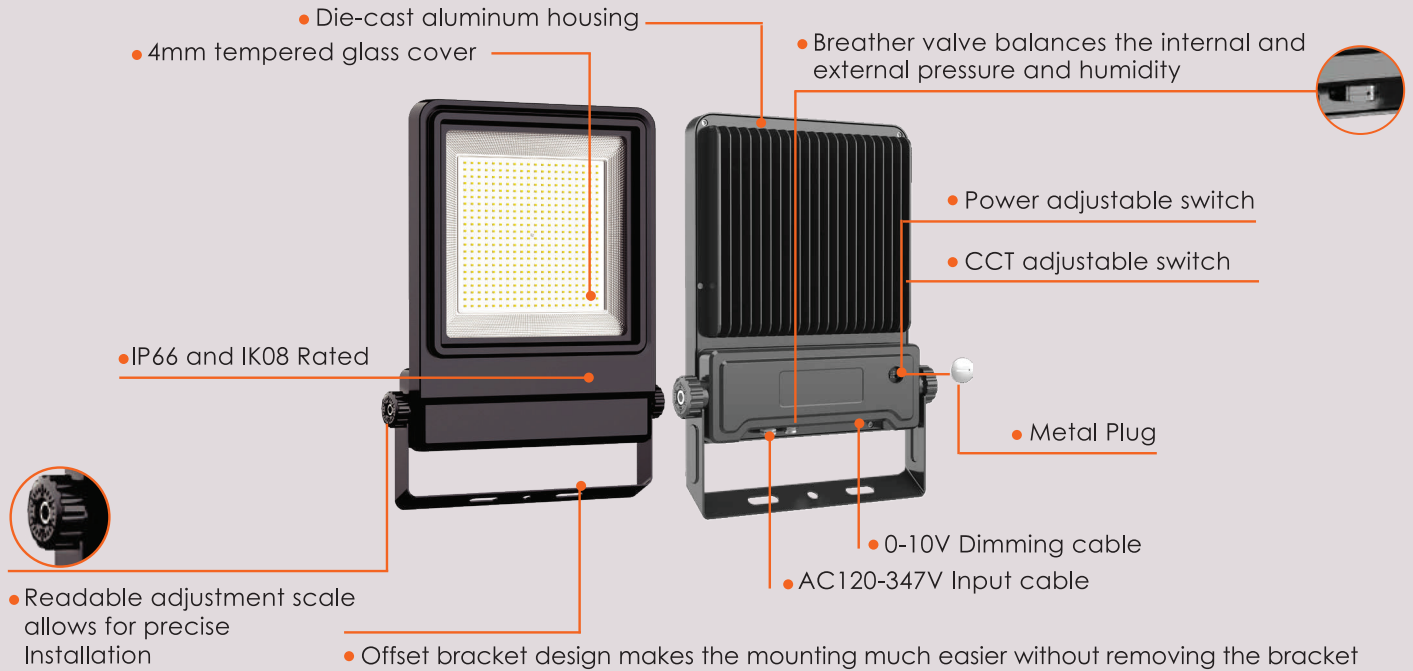

**ISL-FL02-A-200/250/300W**

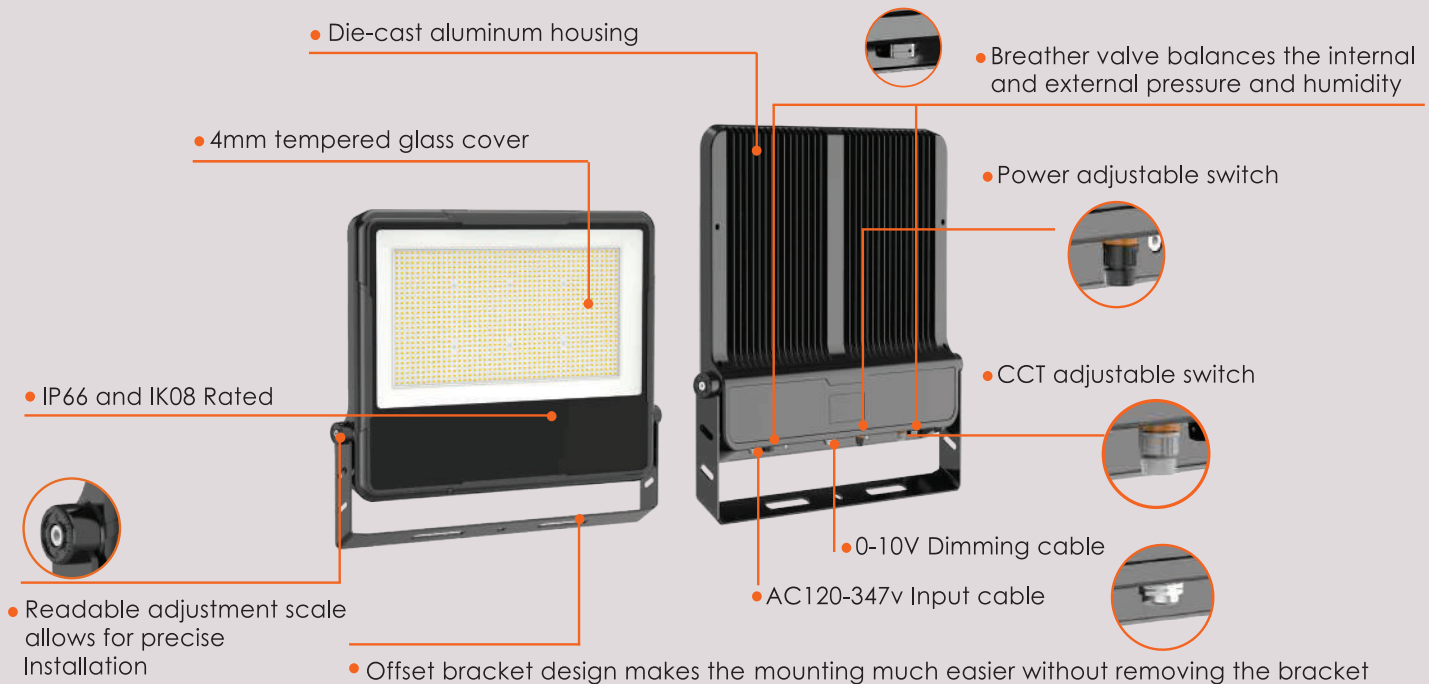

**ISL-FL03-A-500W**

### Installation

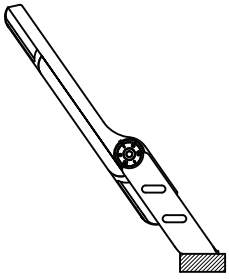

Base Mounting

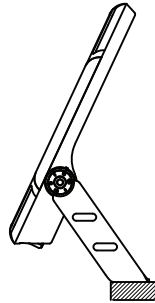

U Bracket Mounting

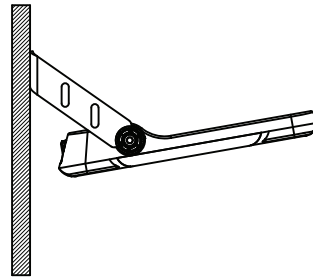

Wall Mounting

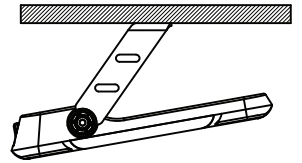

Ceiling Mounting

### Lumen Details

Model No.:	Watts (W)	3000K		4000K		5000K	
		Lumen Output (LM)±5%	Efficiency (LM/W)5%	Lumen Output (LM)5%	Efficiency (LM/W)5%	Lumen Output (LM)5%	Efficiency (LM/W)5%
ISL-FL02-A-200W	200W	30,000LM	150lm/W	32,000LM	160lm/W	30,000LM	150lm/W
	150W	22,500LM	150lm/W	24,000LM	160lm/W	22,500LM	150lm/W
	100W	15,000LM	150lm/W	16,000LM	160lm/W	15,000LM	150lm/W
ISL-FL02-A-250W	250W	37,500LM	150lm/W	40,000LM	160lm/W	37,500LM	150lm/W
	200W	30,000LM	150lm/W	32,000LM	160lm/W	30,000LM	150lm/W
	150W	22,500LM	150lm/W	24,000LM	160lm/W	22,500LM	150lm/W
ISL-FL02-A-300W	300W	45,000LM	150lm/W	48,000LM	160lm/W	45,000LM	150lm/W
	240W	36,000LM	150lm/W	38,400LM	160lm/W	36,000LM	150lm/W
	200W	30,000LM	150lm/W	32,000LM	160lm/W	30,000LM	150lm/W
ISL-FL03-A-500W	500W	75,000LM	150lm/W	80,000LM	160lm/W	75,000LM	150lm/W
	400W	60,000LM	150lm/W	64,000LM	160lm/W	60,000LM	150lm/W
	300W	45,000LM	150lm/W	48,000LM	160lm/W	45,000LM	150lm/W

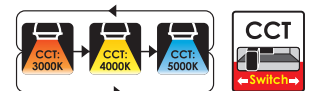

Data is based upon tests performed in a controlled environment. Actual performance can vary depending on operating conditions. All products are subject to change or may be discontinued any time without notice. Please contact your Votatec customer service representative to confirm inventory levels at time of order.

