

Optional Function:

This fixture is designed with integrated function of 3 CCT tunable, 3 wattage adjustable, and the settings can be customized.
Operation: Remove the plug, adjust the switches as indicated to select the desired CCT, wattage. Then screw the plug back after finished setting.
The original settings can be the factory default settings or be customized.

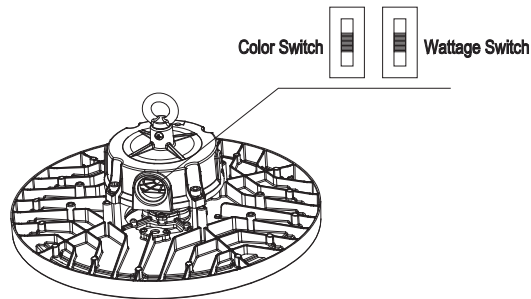

LED High Bay Light Installation Instruction

Cautions:

1. Do not use any electric generator to test the LED light.
2. Please abide by related country, regional and local law and regulations when installing this fixture.
3. Please turn off the power before installation or maintenance.
4. Proper earth grounding is required to ensure safety.

Notice:

1. To avoid possibility of electrical shock or fire, the installation personnel must have professional electric knowledge.
2. Please wear gloves to avoid injury before installation.
3. If any smoke or spark of the wire happened, please turn off the power immediately and notify relevant personnel.
4. Please use listed water proof strain relief bushing when connecting the supply cord to the outlet box.

Attention:

1. Please check if there is any damage during shipping. If so, please contact manufacturer timely.
2. Please read the installation instruction carefully to check whether all the accessories are complete. After confirmation, install the fixture according to installation steps.

Wiring Diagram & Instruction:

- 3 dimming functions are available in this high bay light:
1. Constant current can be achieved by 0-10V DC dimming;
 2. PWM signal dimming;
 3. Variation of resistance unit dimming.

Description:	
This product is 0/1-10V dimming, below dimmers are recommended:	
Brand	Model
LUTRON	NTSTV-DV
LEVITON	DS710-10Z / IP710
LEGRAND	RH4FBL3PW

Wiring Instruction:

ACL: Black/Brown, ACN: White/Blue, ⊕ Green/Yellow, DIM +: Purple, DIM -: Pink AUX: Black/White (As for the wire color of DIM+ and DIM-, pls check the light label.)

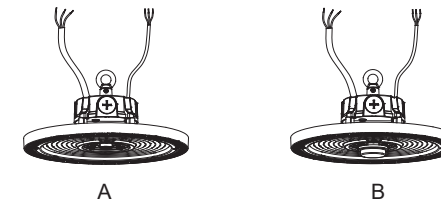

Please choose the appropriate dimming way according to your needs. You can also choose not to use this function.

*The product can not be connected to a dimming device when it's equipped with Motion Sensor.

Installation Methods: Hook Mount, Ceiling Mount, 1/2" NPT Mount. (Please choose the most suitable installation method for the purchased product as per your needs)

A. Hanging Mount: (Hook or eyebolt)

- Step 1. Screw the hook into the fixture, tighten and fix it. (figure 1)
- Step 2. Hang the fixture on the ceiling hook or chain. (figure 2)
- Step 3. After installation, connect the wire of the fixture to the mains according to local wiring rules, ensure the connection is stable and make good protection on the connection.

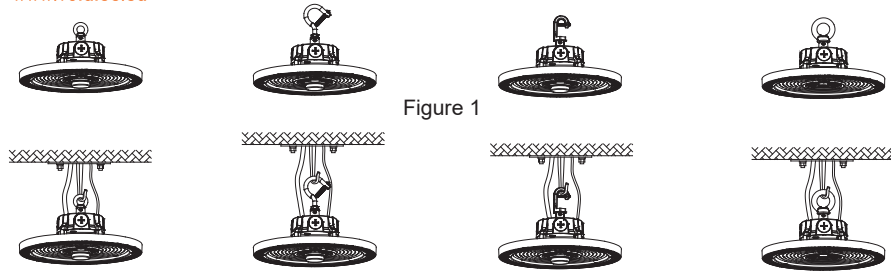

Figure 1

Figure 2

B. Ceiling Mount:

- Step 1. Mark with a mark pen or sharp tool on the mounting surface and drill. (Figure 3)
- Step 2. Fix screws into the holes with a hammer. (Figure 4)
- Step 3. Align the bracket hole with screw hole (Figure 5), and push the fixture to one side (Figure 6) and fix it.
- Step 4. After installation, connect the wire of the fixture to the mains according to local wiring rules, ensure the connection is stable and make good protection on the connection. By adjusting the brackets screws, users can adjust 50° to the left or right vertically. (Figure 7)

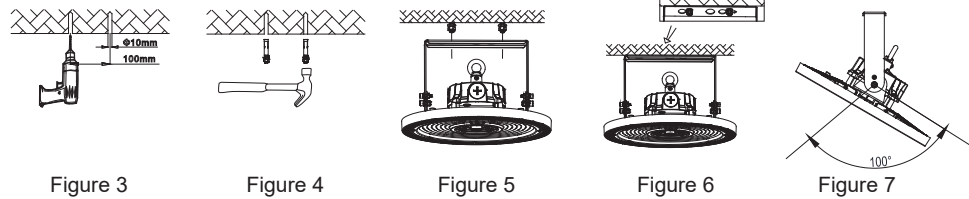

Figure 3

Figure 4

Figure 5

Figure 6

Figure 7

C. 1/2" NPT Mount:

- Step 1. Unscrew the nuts on 1/2" NPT. (Figure 8)
- Step 2. Insert 1/2" NPT stem into the bracket hole. (Figure 9)
- Step 3. Re-screw the nuts. (Figure 10), After installation, connect the wire of the fixture to the mains according to local wiring rules, ensure the connection is stable and make good protection on the connection. By adjusting the brackets screws, users can adjust 50° to the left or right vertically.

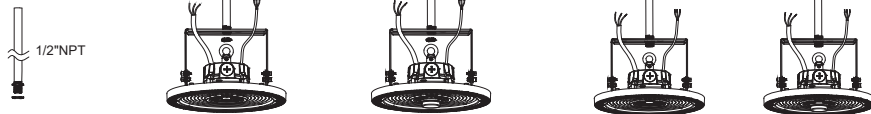

Figure 8

Figure 9

Figure 10

Extra Accessory Option Installation: 1:Wire Guard, 2:Motion Sensor / PIR Sensor, 3: Aluminum reflector/PC reflector 4: Safety cable:

- 1. **Wire Guard:** (Purchase the correct size wire guard from manufacturer) Place the wire guard on the lamp and fix it with screws. (Figure 11)

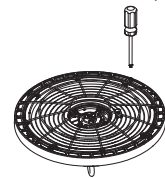

Figure 11

2. DC Motion Sensor / PIR Sensor (Both sensors are with the same installation method)

- Step 1. Use a screwdriver to remove the 1/2 plug from the sensor; (Figure 12)
- Step 2. Twist-lock the DC sensor to the base to make it work properly, use a remote control to adjust the working mode as per demand. (Figure 13)



Figure 12

Figure 13

3: Aluminum reflector / PC reflector

- Step 1. Lock the PC reflector or Aluminum reflector to the lamp with screws.
- Step 2. Installation complete. (Figure 14)

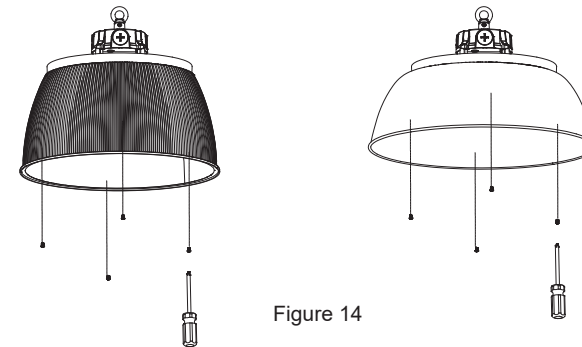

Figure 14

4: Safety cable:

- Step 1. Fix the safety rope on the lamp body with screws. (Figure 15)
- Step 2. Fix the safety buckle on the rail, and the installation is finished.

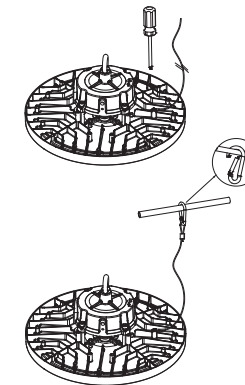

Figure 15