



Innovation & Quality

[www.votatec.ca](http://www.votatec.ca)

VO-DMRW150-120-WIFI

These dimmers are designed to dim incandescent, halogen and LED bulbs smoothly. Dimming range will vary depending on the bulb type.

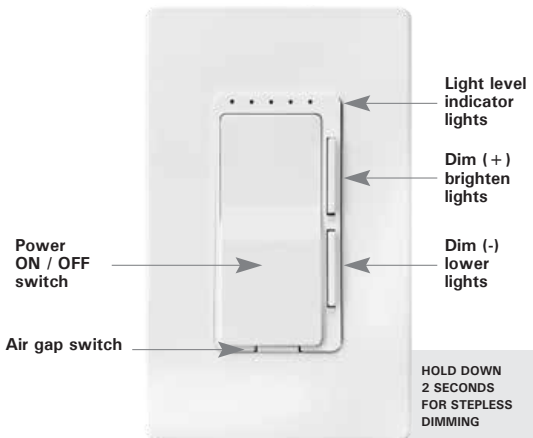

120V - 60Hz

150W max - Dimmable LED

500W max - Incandescent and Halogen

**IMPORTANT, RETAIN FOR  
FUTURE REFERENCE: READ CAREFULLY**

**INSTALLING THE DIMMER**

- 1** **WARNING: TO AVOID FIRE, SHOCK OR DEATH, TURN OFF POWER AT CIRCUIT BREAKER OR FUSE AND TEST THAT POWER IS OFF BEFORE WIRING.**
  - 2** **IDENTIFY YOUR WIRING: SINGLE POLE OR 3-WAY**
- 

**PARTS INCLUDED**

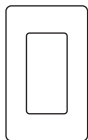

**Decorative  
wall plate (1)**

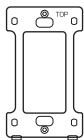

**Mounting  
frame (1)**



**Dimmer (1)**



**Inner Frame  
Screws**



**Frame Screws**



**Wire labels  
(12)**

- 2a. Determine if you have single pole or 3-way wiring and label your wires. Review Diagram A and B below to find the closest match.

### SINGLE POLE

Diagram A

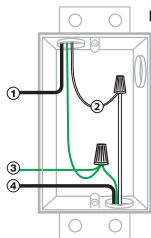

1. LINE (HOT)
2. NEUTRAL
3. GROUND
4. LOAD

#### 2b. Label your wires:

1. Label the incoming 120V line (HOT) wire (usually black) with the black label AC-L.
  2. Label the green wire or bare wire GROUND with the green label G.
  3. Wire (usually white) NEUTRAL with the white label AC-N
  4. Label the other wire LOAD with the red label LOAD.
- 2c. Disconnect wires and remove the old switch

### 3-WAY

Diagram B

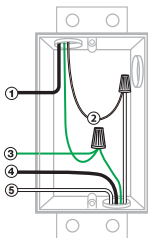

1. LINE (HOT)
2. NEUTRAL
3. GROUND
4. FIRST TRAVELER  
NOTE COLOR
5. SECOND TRAVELER  
NOTE COLOR
6. LOAD

#### 2b. Label your wires:

First, determine which location is the "LINE side" and the "LOAD side".

NOTE: The old switch may have a screw terminal of a different color (usually black). The wire connected to this terminal will connect either to the 120V "Line" or to the fixture "Load".

Second, determine the two TRAVELER wires that travel between the switch locations.

In the location connected to the incoming 120V "LINE"

1. Label the incoming 120V line (HOT) wire (usually black) with the black label AC-L.
2. Label the black TRAVELER wire T1 and the second TRAVELER wire T2.

3. Label the green or bare copper ground wire with the green label G.

4. Label the NEUTRAL wire with the white label AC-N

In the location connected to the fixture "LOAD"

1. Label the wire running to the fixture LOAD (usually black) with the red label LOAD.
2. Label the black TRAVELER wire T1 and the second TRAVELER wire T2.
3. Label the green or bare copper ground wire with the green label G.
4. Label the NEUTRAL wire with the white label AC-N

## 3a. SINGLE POLE

One dimmer on a circuit

Make the wire connections

1. Insert the black wire labeled AC-L into the hole on the back of the dimmer marked AC-L and tighten the screw terminal until the wire is tightly held.
2. Insert the wire labeled LOAD into the hole on the back of the dimmer marked YL/RD and tighten the screw terminal until the wire is tightly held.
3. Insert the incoming NEUTRAL(white) wire labeled AC-N into the hold on the back of the dimmer marked AC-N. Insert the other NEUTRAL(white) wire into the other hold marked AC-N. Tighten the screw terminal until the wires are tightly held. If you do not have this wire, this Smart Dimmer switch is not compatible.
4. Insert the GROUND wire labeled G into the hole on the back of the dimmer marked G and tighten the screw terminal until the wire is tightly held.

#### PREPARING AND CONNECTING WIRES

Use with #12 or #14 AWG solid copper wire or copper-clad wire. Strip wires to 0.80 inch.

Insert wires into terminal holes and secure connections by tightening terminal screws as shown.

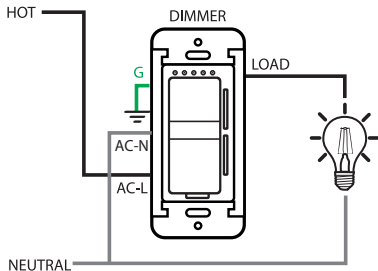
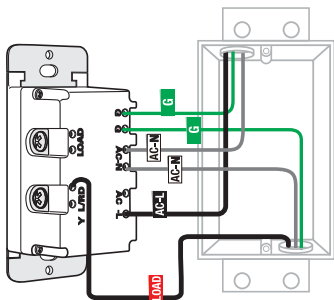
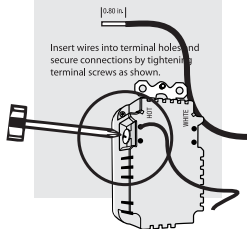

### 3b. 3-WAY

## One Smart Dimmer with a Switch on the Same Circuit

### MAKE THE WIRE CONNECTIONS

🔧 For the Switch in the location connected to the INCOMING 120V LINE:

THE SWITCH MUST BE INSTALLED IN THIS LOCATION.

1. Locate the wire marked AC-L. Connect it to the 3-way switch and the T1 TRAVELER as show.
2. Locate the wire marked T2. Connect it to the 3-way switch and the T2 TRAVELER as show.
3. Connect the GROUND wires as show. The ground wire may be bare copper or may be green color. Attach one GROUND wire to the switch and connect the other GROUND wires as show.

🔧 For Smart Dimmer in the location connected to the LOAD (FIXTURE):

THE DIMMER MUST BE INSTALLED IN THIS LOCATION.

1. Insert the wire labeled **LOAD** into the hole on the back of the dimmer marked **YL/RD** and tighten the screw terminal until the wire is tightly held.
2. Insert the wire marked **T1** (possibly colored black), into the hole on the back of the dimmer marked **AC-L** as shown and tighten the screw terminal until the wire is tightly held.
3. Take the wire marked **T2** and insert it into the hole on the back of the dimmer marked **YL/RD** as shown and tighten the screw terminal until the wire is tightly held.
4. Insert the two **NEUTRAL** (White) wires into the holes on the back of the dimmer marked **AC-N** as shown and tighten the screw terminal until the wire is tightly held.
5. Connect the **GROUND** wire as shown. The ground wire maybe bare copper or maybe green color. Insert the **GROUND** wire into the hole on the back of the dimmer marked **G** and tighten the screw terminal until the wire is tightly held.

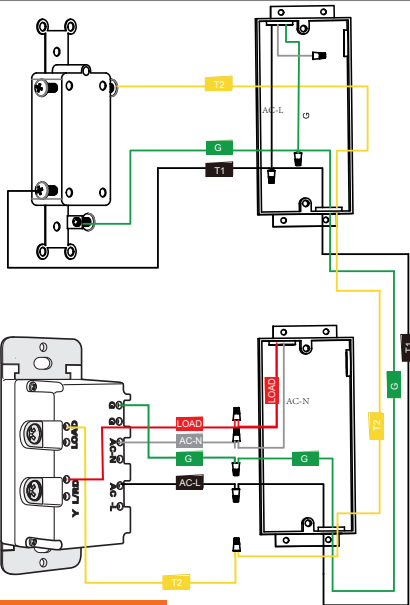

#### 3 WAY-1: 1 DIMMER + 1 SWITCH (DEFAULT)

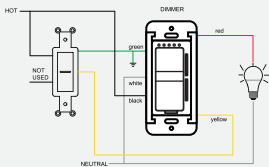

#### 3 WAY-2: 1 DIMMER + 1 DIMMER (NOT RECOMMENDED)

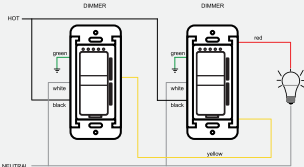

### Two modes of switching:

Turn on the dimmer, press and hold UP for 3 seconds.

- The indicator light flashes once. Switch to mode 3 Way-1
- The indicator light flashes twice, and switch to mode 3 Way-2

#### 4 FIT DIMMER INSIDE THE WALL-BOX

- Carefully position all wires inside the wall-box, leaving enough room to insert the dimmer housing.
- Secure the dimmer inside the wall-box using the provided mounting screws.

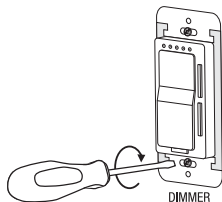

#### 5 SEPARATE MOUNTING FRAME FROM WALL PLATE

- Gently insert screwdriver into slots to separate mounting frame from wall plate.

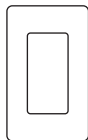
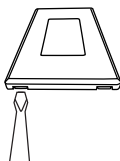

WALL PLATE



MOUNTING FRAME

#### 6 INSTALL MOUNTING FRAME

- Place the mounting frame over your installed dimmer and secure it using provided screws.

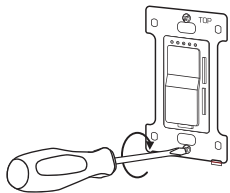

#### 7 INSTALL WALL PLATE

- Snap the decorative wall plate over the installed mounting frame with the top first then the bottom.

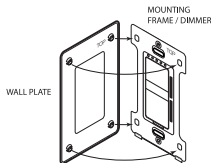

WALL PLATE SNAPS ONTO MOUNTING FRAME

## 8

## SET YOUR DIMMING RANGE AND TROUBLESHOOT FLICKERING

If you experience flickering, first tighten any loose bulbs and ensure all bulbs are rated “dimnable”. If flickering continues, it may be caused by irregular power surges and spikes of electric energy moving along power lines and building wiring. Flickering more frequently occurs at lower dim levels.

There is one to set the lowest possible dimming level which may help with flickering. You can set this low-dim point manually on the dimmer.

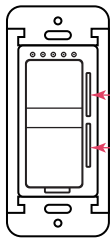

1. Press and hold dim (+) and dim (-) buttons simultaneously for at least 5 seconds, your lights will flicker once, and be at the current lowest dimming brightness level (<3%). Press and hold dim (+) and dim (-) again, the lights will flicker twice, and the lowest dimming brightness level will be adjusted to 5%. Press and hold dim (+) and dim (-) again, the lights will flicker three times, and the lowest dimming brightness level will be adjusted to 8%.
2. Hold either dim (+) or dim (-) to adjust light until you do not experience flickering. In some circumstances, your bulbs may be at a significantly bright light level.
3. Once you are at the minimum brightness level without flickering, you will now be able to dim up to 100% and down to your set minimum brightness.

### LIGHT LEVEL INDICATOR LIGHTS

- The LEDs will light up to indicate the selected brightness level.

From left to right:

LED 1	LED 2	LED 3	LED 4	LED 5
1%-20%	21%-40%	41%-60%	61%-80%	81%-100%

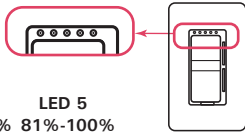

### TROUBLESHOOTING TIPS

Lights are flickering:

- Lamp has a bad connection.
- The wire connections are not firmly secured.
- Set your dimming range and troubleshoot flickering.

Light does not turn ON:

- Circuit breaker or fuse has tripped.
- Bulb or lamp is burned out.



**Innovation & Quality**

[www.votatec.ca](http://www.votatec.ca)

**VO-DMRW150-120-WIFI**

### *Before you begin*

- Make sure your mobile device is running the latest version of iOS or Android.
- Verify your network and ensure your mobile device is connected to a 2.4 GHz Wi-Fi channel.

### **Install the “Smart Life”APP**

**Step A** .Find out “Smart Life”app in Apple app store, Google Play, or scan the QR code bellow and install it.



The free app”Smart Life” is compatible with mobile devices the support IOS8.0 above, Android 4.4 above

**Step B** .Enter the register interface, input the email address/phone number for getting the verification code to register an account. Please just login if you already have a Smart Life account.



## Step C: Add the switch to Smart Life APP

Note: This smart switch can only support 2.4G network and cannot work with 5.0G network. please check if your home network is 2.4G and make sure that your phone has been connected to your WI-FI home network

(1) Tap "+" button on top right corner to add device, the tap "switch" to enter next page.

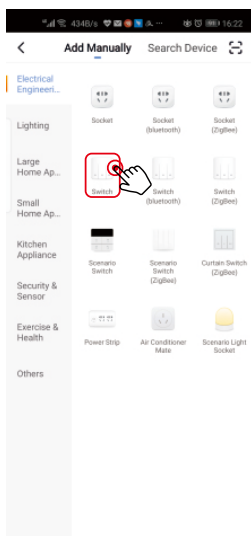
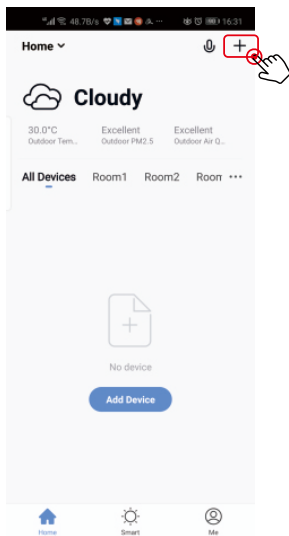

## Step D: Pair your dimmer

Long press the round ring in the middle for about 3s and release, the ring will flicker in blue color, showing that dimmer is under pairing. Add Device from APP to connect it to your cellphone.

Once it is paired, round ring will stop flickering.

Now you can start smart controls over the dimmer

