

Project : _____
 Type : _____
 Drawn by : _____
 Catalogue No. : _____
 Date : _____

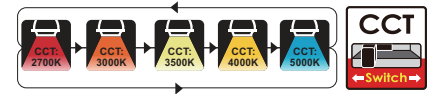

Specifications

	Model No.	<input type="checkbox"/> RP4W10-120-D-5Way-FR	<input type="checkbox"/> RP6W13-120-D-5Way-FR
General	Watts	10W	13W
	HID Equivalent	60W	75W
	Lumen	820L	1100L
	CCT	2700K/3000K/3500K/4000K/5000K	2700K/3000K/3500K/4000K/5000K
	Volts	120V	120V
	CRI	>80	>80
	Beam Angel	40°	40°
	Hours Rated	50000 hours	50000 hours
	Min Compartment Size	Ø4.9"x1.7"	Ø7.1"x1.7"
Electrical	Operating Frequency	50-60Hz	50-60Hz
	Power Factor	>0.9	>0.9
	Operating Position	Both Horizontal&Vertical	Both Horizontal&Vertical
	Surge Protection	Built-in surge protection-2.5KV	Built-in surge protection-2.5KV
	Operating Temperature	-20°C /-4°F to 40°C/104°F	-20°C /-4°F to 40°C/104°F
Physical	Lens Material	PMMA	PMMA
	Housing Color	White	White
	Weight (Kg)	0.27	0.66
Additional Information	Additional Info	5 way CCT	5 way CCT
	Rated For Enclosed Fixture	Yes	Yes
	Warranty	5 years	5 years
Compliance	Safety Listing	CETLus-Listed	CETLus-Listed
	Location Rating	Wet	Wet
	Energy Star	YES	YES
	DLC Approved	No	No
	DLC ID	No	No

Features & Specifications

Construction	<ul style="list-style-type: none"> • Construction: Steel with frosted lens • Multiple LED array for uniform illumination • Rotatable multi-axis gimbal ring • CCT switches are placed discretely outside the driver housing
Mounting	<ul style="list-style-type: none"> • Easy installation for remodel or new construction applications With 2700K/3000K/3500K/4000K/5000K 5CCT selectable
Performance Data	<ul style="list-style-type: none"> • Available in 2700k/3000k/3500k/4000k/5000k selectable color temperature • 80+ CRI • Electrical ratings: 120v • Estimated life of over 100 000 hours to L70 • ELV&TRIACDimming • 2.5kV surge protection (standard) • Operating temperature: -20°C /-4°F to 40°C/104°F
Compliances	<ul style="list-style-type: none"> • ETL certified for wet locations • IP20 • ES listed • UL 263 ,ASTM E119& CAN/ULC S 101

Dimensions & Weights

Model	RP4W10	RP6W13
Diameter in.(mm)	4.92(125)	7.09(180)
Height in. (mm)	1.69(42)	1.74(44)
Net weight (lbs)	0.58	1.45

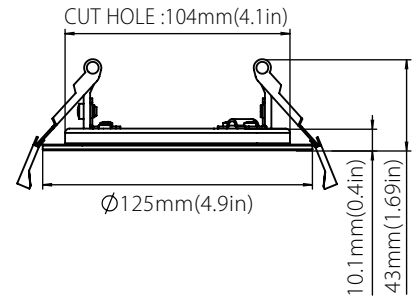
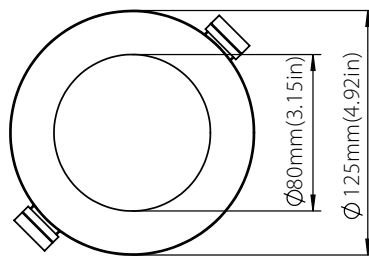

RP4W10

- RP4W10 Cut Hole : 104mm(4.1in)
- RP6W13 Cut Hole : 159mm(6.26in)

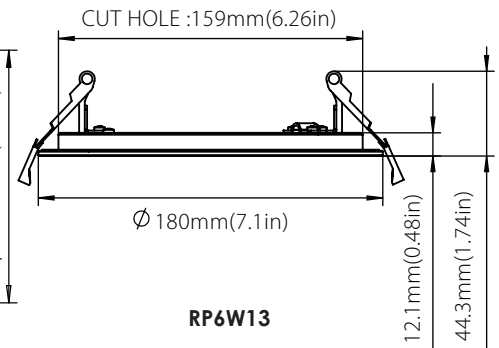
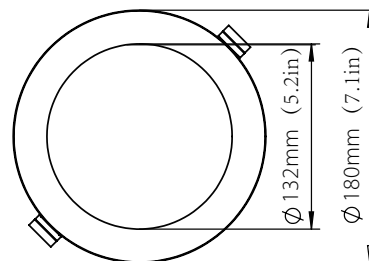

RP6W13

Product Details

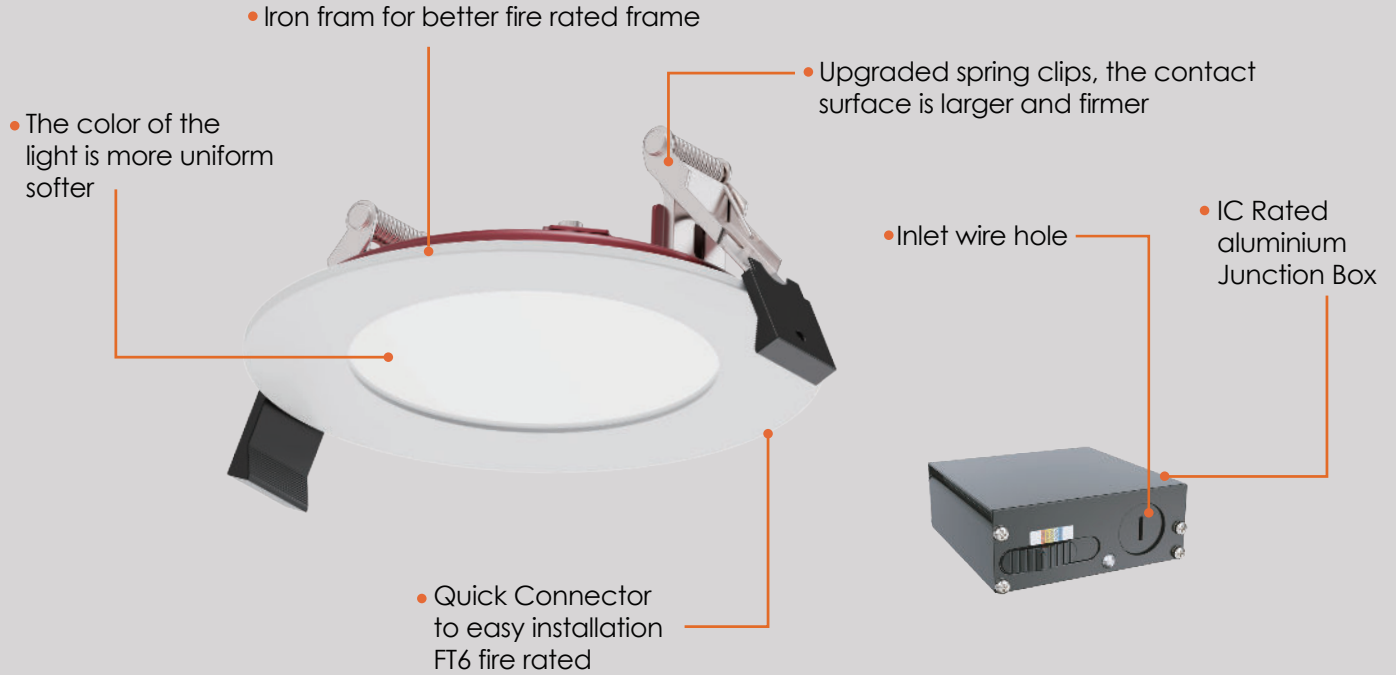

Compatible Dimmers

BRAND	MODEL
HILUTRON	DVCL-153PLH
LUTRON	S600-P
LUTRON	DV600-P15
LUTRON	MACL-153M
LUTRON	CTCL-153P
LUTRON	MS-OPS2
LUTRON	CTCL-153P
LUTRON	PD-6WCL
LEVITON	6674
LEVITON	6681

Dimming range : 10%-100%

This table shows dimmers that have been tested and have demonstrated proper operation under normal conditions. Each installation being unique, various factors such as load, common neutrals or other electrical products on the circuit can, in certain instances, cause variance in system performance.

Read and comply to the dimmer installation instructions. Some dimmers may require more than one product for stable operation.

recommends to use dimmers designed to work with LED products. Older dimmers designed for incandescent products may cause erratic operation.

Lumen Details

Model No.:	Watts (W)	2700K		3000K		3500K		4000K		5000K	
		Lumen Output (LM)	Efficiency (LM/W)	Lumen Output (LM)	Efficiency (LM/W)	Lumen Output (LM)	Efficiency (LM/W)	Lumen Output (LM)	Efficiency (LM/W)	Lumen Output (LM)	Efficiency (LM/W)
RP4W10-120-D-5Way-FR	10W	820LM	82	834LM	84	867LM	87	891LM	89	831LM	83
RP6W13-120-D-5Way-FR	13W	1100LM	85	1147LM	89	1264LM	97	1326LM	102	1274LM	98

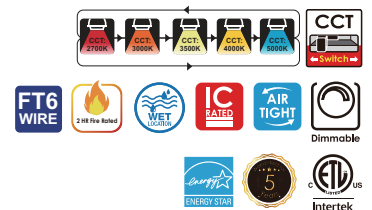

Data is based upon tests performed in a controlled environment. Actual performance can vary depending on operating conditions. All products are subject to change or may be discontinued any time without notice. Please contact your Votatec customer service representative to confirm inventory levels at time of order

