

Project : _____
 Type : _____
 Drawn by : _____
 Catalogue No. : _____
 Date : _____

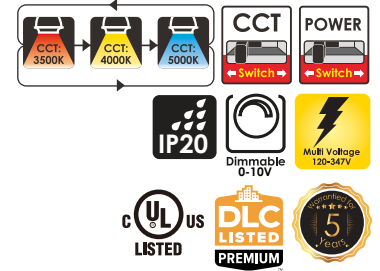

Specifications

Model No.	<input type="checkbox"/> VO-ARTF22W40-347-3Way-B-PX	<input type="checkbox"/> VO-ARTF24W50-347-3Way-B-PX	
General	Watts	25-30-40W	30-40-50W
	Halogen Equivalent	Min.40W, Max. 80W	Min.45W, Max. 105W
	Lumen	3125-3750-5000LM	3750-5000-6250LM
	Efficiency	125LM/W	125LM/W
	CCT	3500/4000/5000K ADJ	3500/4000/5000K ADJ
	Volts	AC120-347V	AC120-347V
	CRI	>80	>80
	Beam Angel	120degree	120degree
	Hours Rated	50000 hours	50000 hours
	Installation ways	Recessed, surface mounted, suspended	Recessed, surface mounted, suspended
Electrical	IP rating	IP20	IP20
	Operating Frequency	50-60Hz	50-60Hz
	Power Factor	>0.9	>0.9
	Flicker percentage	<5%	<5%
	Surge Protection	L/N-1KV	L/N-1KV
	Operating Temperature	-20°C TO 40°C	-20°C TO 40°C
Physical	Dimension	23.7X23.7X1.49 in	23.7X23.7X1.49 in
	Frame	Aluminum	Aluminum
	Frame color	RAL9003	RAL9003
	Lens material	PMMA	PMMA
	Weight	5.51 lb	10.8 lb
Additional Information	Warranty	5 years	5 years
Compliance	Safety Listing	CUL-Listed	CUL-Listed
	Location Rating	Damp	Damp
	Energy Star	No	No
	DLC Approved	Yes, DLC Premium	Yes, DLC Premium

Features & Specifications

Construction	<ul style="list-style-type: none"> • Tri-zone lighting architectural Troffer, 3 center lens aesthetics special butterfly wings design brings different visual experience • Angled lens provides depth, and the convenience of Multi CCT and Wattage provides ease of installation, making any application perfectly illuminated. • 3 CCTs and 3 Powers Selectable provides more options on site and save SKU in warehousing • External J-box optional, for adding wiring space • Optional different accessories: PIR sensor, emergency battery
Mounting	<ul style="list-style-type: none"> • T-bar recessed directly • Optional accessories for different installation: suspended kits.
Performance Data	<ul style="list-style-type: none"> • Available in 3500/4000/5000K selectable color temperature • 80+ CRI, SDCM<5 • Electrical ratings: 120-347 V • Estimated life of over 100,000 hours to L70 • 0-10V dimming driver • Flicker percentage<5%, meet IEEE standard • Operating temperature: -20°C to 40°C (-4°F to 104°F)
Compliances	<ul style="list-style-type: none"> • CUL certified for damp locations • DLC5.1 Premium

Dimensions & Weights

Model.No	VO-ARTF22W40-347-3Way-B-PX	VO-ARTF24W50-347-3Way-B-PX
Size in. (mm)	23.7X23.7X2.25 in (602x602x57)	23.7X47X2.25 in (602x1209x57)
Net weight (lbs)	4.08	8.11
Package	2pcs/ctn	2pcs/ctn

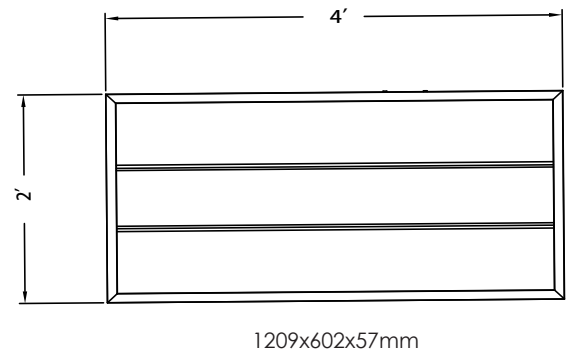
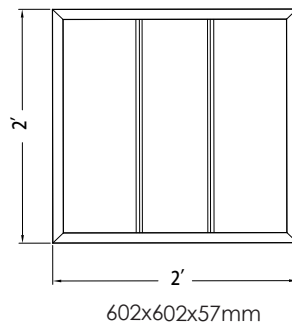

Product Details

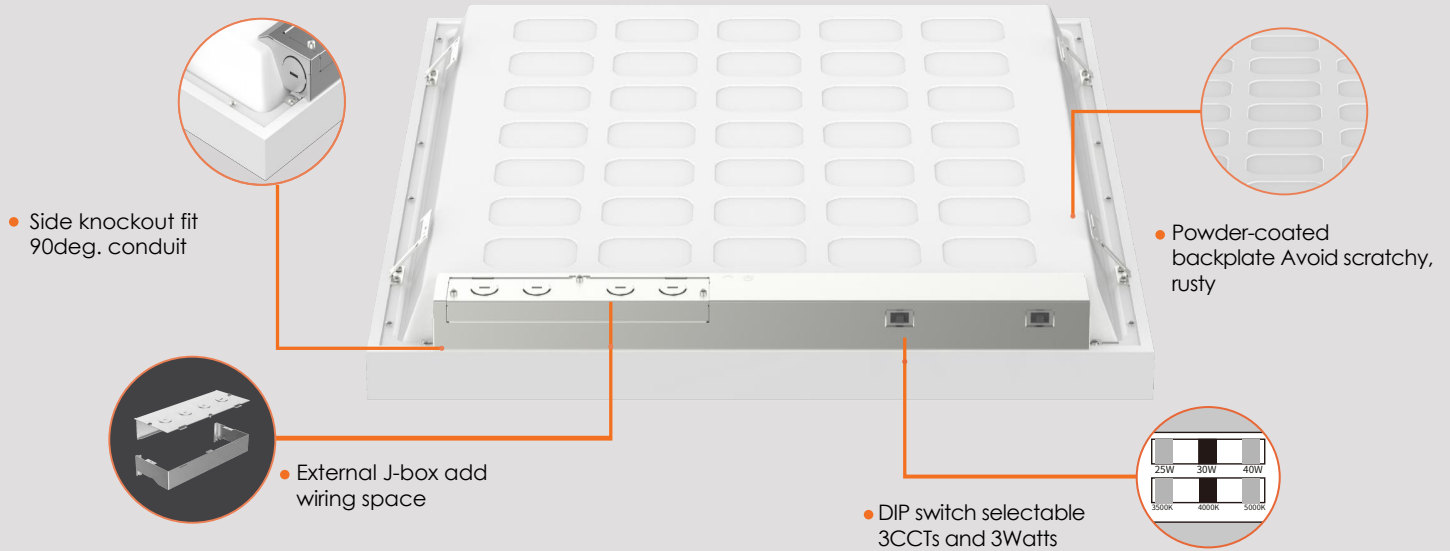

Compatible Dimmers

Brand	Model
LUTRON	DSTV-Diva

Dimming range : 10%-100%

This table shows dimmers that have been tested and have demonstrated proper operation under normal conditions. Each installation being unique, various factors such as load, common neutrals or other electrical products on the circuit can, in certain instances, cause variance in system performance.

Read and comply to the dimmer installation instructions. Some dimmers may require more than one product for stable operation.

recommends to use dimmers designed to work with LED products. Older dimmers designed for incandescent products may cause erratic operation.

Accessories (Order Separately)

Model No.:	Compatible With:
Suspended Kit(MG-D001)	VO-ARTF22W40-347-3Way-B-PX VO-ARTF24W50-347-3Way-B-PX
Extra Junction Box	VO-ARTF22W40-347-3Way-B-PX VO-ARTF24W50-347-3Way-B-PX

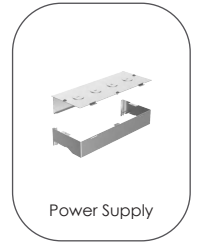
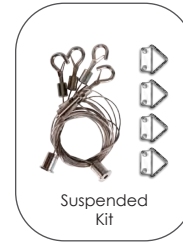

Lumen Details

Model No.:	Watts (W)	3500K		4000K		5000K	
		Lumen Output (LM)	Efficiency (LM/W)	Lumen Output (LM)	Efficiency (LM/W)	Lumen Output (LM)	Efficiency (LM/W)
VO-ARTF22W40-347-3Way-PX	25W	3150	126	3200	128	3175	127
	30W	3780	126	3840	128	3810	127
	40W	5000	125	5080	127	5040	126
VO-ARTF24W50-347-3Way-PX	30W	3750	125	3870	129	3810	127
	40W	4960	124	5160	129	5000	125
	50W	6150	123	6300	126	6100	122

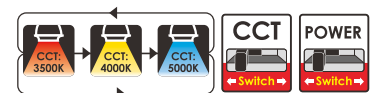

Data is based upon tests performed in a controlled environment. Actual performance can vary depending on operating conditions. All products are subject to change or may be discontinued any time without notice. Please contact your Votatec customer service representative to confirm inventory levels at time of order

