

## Safety Information

Read this installation guide prior to attempting installation. Always turn OFF the main power before starting your installation. Consult a qualified electrician before installation. Installation should be carried out by a qualified electrician.

During installation, basic safety precautions should always be followed, including the following listed:

1. Ensure the appropriate connectors match the luminaire fixture.
2. Do not install any part of the luminaire less than 5 feet above the floor.
3. Do not install any luminaire assembly closer than 5 inches from any window treatments, i.e., curtain, blinds or any similar combustible type material.
4. Do not attempt to energize anything other than the luminaire fixtures.
5. To reduce the risk of fire or electric shock, do not connect this fixture to power tools, extension cords, or appliances.
6. Maintenance of the luminaires should be performed by person(s) familiar with the luminaires' construction and operation and any hazards involved. Regular fixture maintenance programs are recommended.
7. Do not exceed the nominal supply voltage or amperage ratings.
8. Turn the power OFF at the fuse or circuit breaker box before doing any installation or maintenance activities.
9. Wear rubber soled shoes and work on a sturdy wooden or non-conductive ladder.
10. The lighting product must be mounted in locations and at heights in compliance with the National Electrical Code and with local electrical codes.
11. To avoid hazards to children, take accountability for all parts and dispose all packing materials properly.
12. It may be necessary to clean the refractor/lens. Frequency of cleaning will depend on ambient dirt level and minimum light output which is acceptable to the user. Refractor/lens should be washed in a solution of warm water and any mild, non-abrasive household detergent, rinsed with clean water and wiped dry. Should optical assembly become dirty on the inside, wipe refractor/lens and clean in above manner, replacing damaged gaskets as necessary.
13. Do not install a damaged product. This luminaire has been properly packed so that no parts should have been damaged during transit. Inspect to confirm. Any part damaged or broken during or after assembly should be replaced.
14. These instructions do not purport to cover all details or variations in equipment nor to provide every possible contingency to meet in connection with installation, operation or maintenance. Should further information be desired or particular problems arise, not covered sufficiently for the purchaser's or owner's purposes, please contact the Technical Team.



**WARNING:** This equipment is intended to be installed only by qualified personnel. The installation must be made in accordance with the current edition of the National Electrical Code (NEC) and all applicable state and local building codes. The final installation must be approved by the appropriate, qualified electrical/building inspector(s). Improper installation may result in a fire or electrical hazard. Ensure the electrical power to the circuit has been disconnected before installing the electrical system.



**WARNING:**

1. Risk of fire. Most dwellings built before 1985 have supply wire rated at 60°C.
2. Consult a qualified electrician before installation, properly ground electrical enclosure.
3. To prevent wiring damage or abrasion, do not expose wiring to edges of sheet metal or other sharp objects.
4. Use only UL approved wire for input/output connections. Minimum size 18 AWG or 14 AWG if there are any continuous runs.
5. If the fixtures are connected in a continuous run, do not exceed allowable number of fixtures in series/power in continuous runs.
6. Inrush currents must be taken in account by the electricians to account for proper circuit design.

# Votatec

## Innovation & Quality

8" Commercial Downlight



## Installation Instructions



## Dimensions

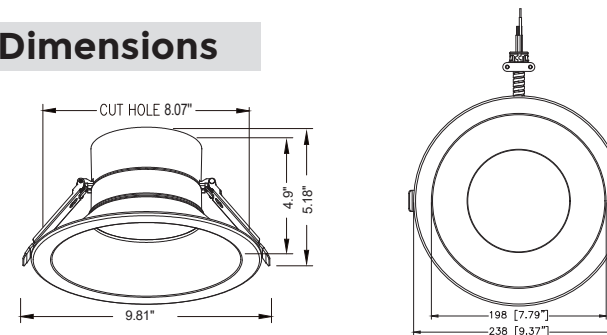

Model	Size	D1(Trim Dim)	D2(Luminous Dim)	A(Total Width)	H1(Total Height)	H2(Height Assembled)	Cut Hole Dim
VO-COM8W40-347-5WAY	8" Round	9.37"/238mm	7.79"/198mm	9.81"/249mm	4.9"/125mm	5.18"/132mm	8.07"/205mm

## Mounting steps new construction installation

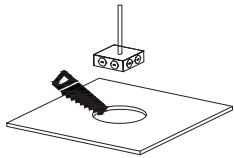

1. If using a new construction plate, install it in the ceiling first. If a new hole is needed, cut a hole according to the luminaire cut-out dimension.

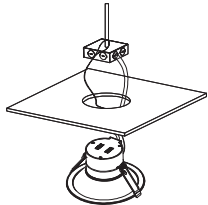

3. Connect the AC main power to the fixture's input leads. Insert the fixture conduit into the J-box and wire to the power source (black to hot, white to neutral, violet to 0-10V dimming positive, gray to 0-10V dimming negative). Reattach the J-box when completed.

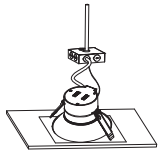

5. Once the fixture is in the ceiling, release the spring clips and push the fixture up into the ceiling until it is securely fixed and flushed to the ceiling.

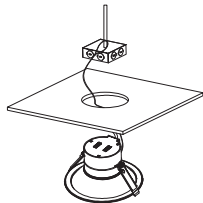

2. Attach the carabiner safety lanyard to secure its place inside the ceiling. Remove the junction box faceplate and disconnect wiring to the existing ballast. Remove the appropriate knock out on junction box.

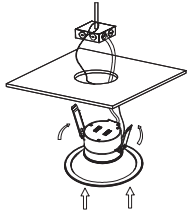

4. Bend spring clips upwards, such that they are in an upright position, and insert fixture into the ceiling and housing.

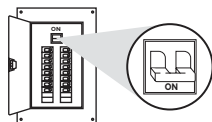

6. Restore the power at the source and the installation is complete.

## Mounting steps retrofit installation

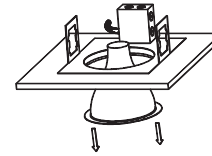

1. Remove existing lamp and reflector. Measure the ceiling opening and ensure the edge of the new luminaire will cover the entire hole.

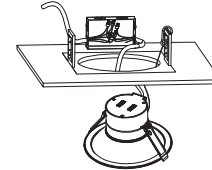

3. Connect the AC main power to the fixture's input leads. Insert the fixture conduit into the J-box and wire to the power source (black to hot, white to neutral, violet to 0-10V dimming positive, gray to 0-10V dimming negative). Reattach the J-box when completed.

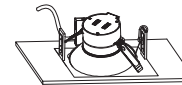

5. Once the fixture is in the ceiling, release the spring clips and push the fixture up into the ceiling until it is securely fixed and flushed to the ceiling.

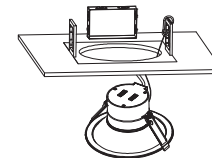

2. Attach the carabiner safety lanyard to the existing fixture housing. Remove the junction box face plate and disconnect the wiring from the existing ballast.

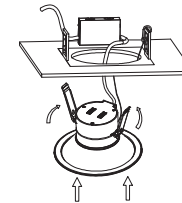

4. Bend spring clips upwards, such that they are in an upright position, and insert fixture into the ceiling and housing.

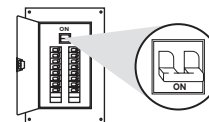

6. Restore the power at the source and the installation is complete.



Note: Turn off electricity at main fuse box (or circuit breaker box) before beginning installation.



Note: Turn off electricity at main fuse box (or circuit breaker box) before beginning installation.