

**GFCI SAFETY OUTLET  
TAMPER RESISTANT**  
GROUND FAULT CIRCUIT INTERRUPTER

**INSTALLATION AND TESTING**

15A 120V 60HZ  
20A 120V 60HZ



Please read this manual completely  
before installing

**CAUTION**

- To prevent severe shock or electrocution, always turn the power OFF at the service panel before working with the wiring.
- Use this GFCI receptacle with copper or copper-clad wire. Do not use it with aluminum wire.
- Do not install this GFCI receptacle on a circuit that powers life support equipment because if the GFCI trips, it will shut down the equipment.
- For installation in damp or wet locations, the GFCI receptacle must be listed and marked as Weather Resistant (WR).
- For installation in wet locations, protect the GFCI receptacle with a weatherproof cover that will keep both the receptacle and any plugs dry.
- Must be installed in accordance with national and local electrical codes.

Tamper resistant mechanism stops access to outlet contacts unless a two-prong plug is inserted.

**1. What is a GFCI?**

A GFCI receptacle is different from conventional receptacles. In the event of a ground fault, a GFCI will trip and quickly stop the flow of electricity to prevent serious injury.

**Definition of a ground fault:** Instead of following its normal safe path, electricity passes through a person's body to reach the ground. For example, a defective appliance can cause a ground fault.

A GFCI receptacle does not protect against circuit overloads, short circuits, or shocks. For example, you can still be shocked if you touch bare wires while standing on a conducting surface such as cement or grease.

**2. The GFCI's features**

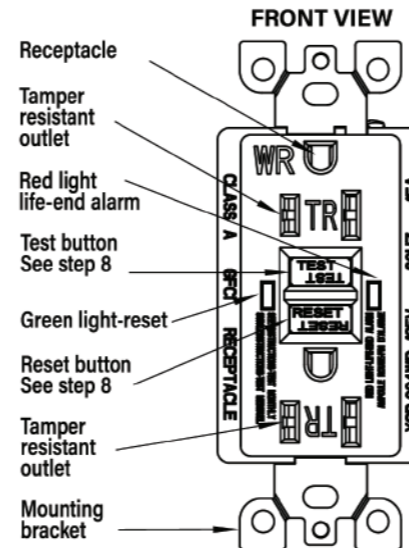

**BACK VIEW**

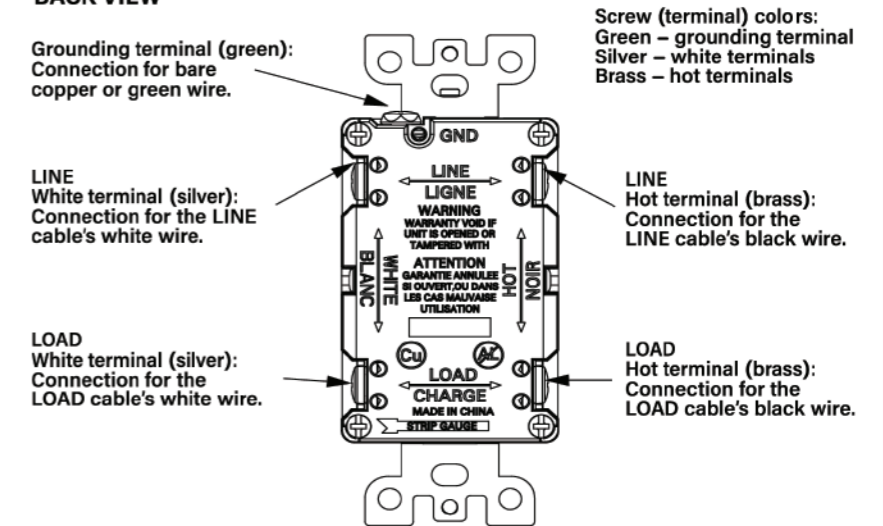

Maximum tightening torque 14in-lbf(1.6N.m)

**3. Should you install it?**

Installing a GFCI receptacle can be more complicated than installing a conventional receptacle.

Make sure that you:

- Understand basic wiring principles and techniques.
- Can interpret wiring diagrams.
- Have circuit wiring experience.
- Are prepared to take a few minutes to test your work, making sure that you have wired the GFCI receptacle correctly.

If you do not fully understand these instructions, you should seek the assistance of a qualified electrician.

**4. Line vs load**

A cable consists of 2 or 3 wires.

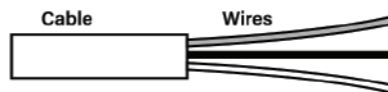

**LINE CABLE:** Delivers power from the service panel(breaker panel or fuse box) to the GFCI. If there is only one cable entering the electric box, it is the LINE cable. This cable should be connected to the GFCI's LINE terminals only.

**LOAD CABLE:** Delivers power from the GFCI to another receptacle/outlet in the circuit. This cable should be connected to the GFCI's LOAD terminals only.

**5. Turn the power off.**

Plug an electrical device, such as a lamp or radio, into the receptacle on which you are working. Turn the lamp or radio on. Then, go to the service panel. Find the breaker or fuse that protects that receptacle. Place the breaker in the OFF position or completely remove the fuse. The lamp or radio should turn OFF.

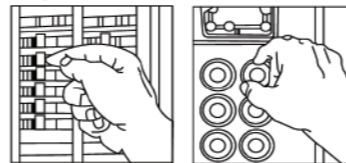

Next, Plug in and turn on the lamp or radio at the receptacle's other outlet to make sure the power is OFF at both outlets. If the power is not OFF, stop work and call an electrician to complete the installation

**6. Identify cables/wires**

**IMPORTANT:** Do not install the GFCI receptacle in an electrical box containing(a) more than 4 wires(not including the grounding wires) or (b) cables with more than two wires (not including the grounding wire). Contact a qualified electrician if either (a) or (b) is true.

- If you are replacing an old receptacle, pull it out of the electrical box without disconnecting the wires.
- If you see one cable (2-3 wires) it is the LINE cable. The receptacle is probably in position C (see diagram to the right). Remove the receptacle and go to step 7A.
- If you see two cables (4-6 wires), the receptacle is probably in position A or B (see diagram to the right). Follow steps a-e of the procedure to the right.

Procedure: box with two cables (4-6 wires)

- Detach one cable's white and hot wires from the receptacle and cap each one separately with a wire connector. Make sure that they are from the same cable.
- Re-install the receptacle in the electrical box, attach the wall plate, then turn the power ON at the service panel.
- Determine if power is flowing to the receptacle. If so the capped wires are the LOAD wires. If not the capped wires are the LINE wires.
- Turn the power off at the service panel, label the LINE and LOAD wires, then remove the receptacle.
- Go to step 7B.

Placement in circuit:

The GFCI's place in the circuit determines if it protects other receptacles/outlets in the circuit.

Sample circuit:

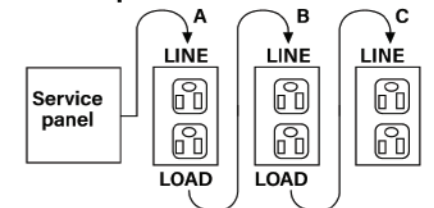

Placing the GFCI in position A will also provide protection to "load side" receptacles/outlets B and C. On the other hand, placing the GFCI in position C will not provide protection to receptacles/outlets A or B. Remember that receptacles/outlets A, B and C can be in different rooms.

**7. Connection the wires (choose A or B) ... only after reading other side completely**

**A: One cable (2-3 wires) entering the box**

**OR**

**B: Two cables (4 or 6 wires) entering the box**

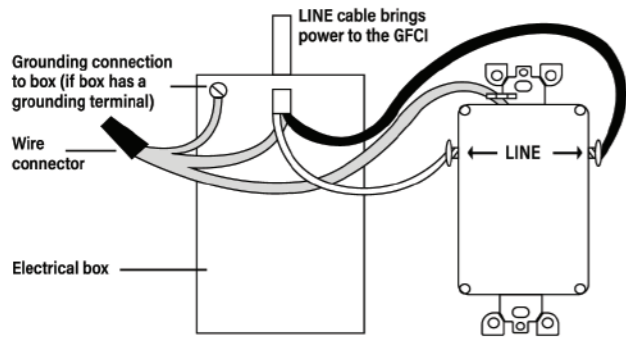

**ABOUT WIRE CONNECTIONS:**

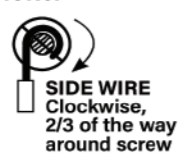
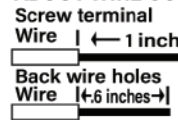

2. Securely tighten screw beneath wire hole to retain inserted wire.

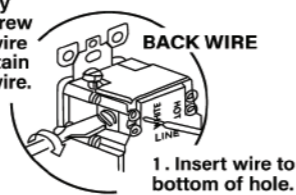

**Connect the LINE cable wires to the LINE terminals:**

- The white wire connects to the white terminal (silver)
- The black wire connects to the hot terminal (brass)

**Connect the ground wire (only if there is a ground wire):**

- For a box with no ground terminal (diagram not shown): Connect the LINE cable's bare copper (or green) wire directly to the ground terminal on the GFCI receptacle.
- For a box with a ground terminal (diagram shown above): Connect a 6 inch bare copper (or green) 12 or 14AWG wire to the ground terminal on the GFCI.
- Also connect a similar wire to the ground terminal on the box. Connect the ends of these wires to the LINE cable's bare copper (or green) wire using a wire connector. If these wires are already in place, check the connections.

**Complete the installation:**

- Fold the wires into the box, keeping the ground wire away from the white and hot terminals. Screw the receptacle to the box and attach the wall plate.
- Go to step 8.

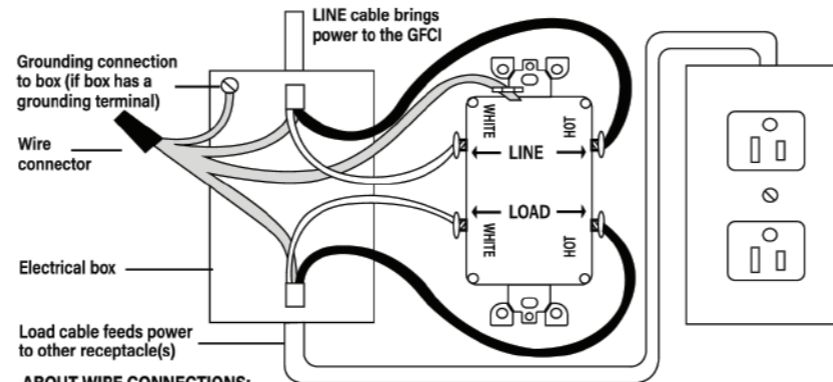

**ABOUT WIRE CONNECTIONS:**

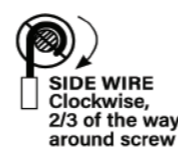
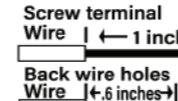

2. Securely tighten screw beneath wire hole to retain inserted wire.

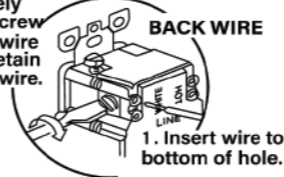

**Connect the LINE cables wires to the LINE terminals:**

- The white wire connects to the white terminal (silver)
- The black wire connects to the hot terminal (brass)

**Connect the LOAD cable wires to the LOAD terminals:**

- The white wire connects to the white terminal (silver)
- The black wire connects to the hot terminal (brass)

**Connect the ground wires as shown above (only if there is a ground wire):**

- Connect a 6 inch bare copper (or green) 12 or 14 AWG wire to the ground terminal on the GFCI. If the box has a ground terminal, also connect a similar wire to the ground terminal on the box. Connect the ends of these wires to the LINE and LOAD cable's bare copper (or green) wire using a wire connector. If these wires are already in place, check the connections.

**Complete the installation:**

- Fold the wires into the box, keeping the ground wire away from the white and hot terminals. Screw the receptacle to the box and attach the wall plate.
- Go to step 8.

**8. Test your work**

**Why perform this test?**

- If you miswire the GFCI it may not prevent personal injury or death due to a ground fault (electrical shock).
- If you mistakenly connect the LINE wires to the LOAD terminals, the GFCI will not reset and will not provide power to either the GFCI receptacle face or any receptacles fed from the GFCI.

**Procedure:**

- This GFCI is shipped from the factory in the tripped condition and cannot be reset until the Line and Load are wired correctly and power is supplied to the device. Turn the power ON at the service panel. Press the RESET button fully. If the indicator (LED) glows green, you have installed the GFCI receptacle correctly. Plug a lamp or radio into the GFCI (and leave it plugged in). Ensure that the GFCI can be tripped by pressing the TEST button. If the GFCI receptacle cannot be reset, the indicator (LED) does not glow, and there is no power in the lamp or radio, go to the Troubleshooting because LINE and LOAD wiring connections have been reversed.
- Press the test button in order to trip the device. This should stop the flow of electricity, making the radio or lamp shut off. Note that the reset button will pop out. If the power goes off, the green indicator (LED) goes out, you have installed the GFCI receptacle correctly. To restore power, press the reset button.
- If you installed your GFCI using step 7B, plug a lamp or radio into surrounding receptacles to see which one(s), in addition to the GFCI, lost power when you pressed the test button. Do not plug life saving devices into any receptacles that lost power. Place a "GFCI Protected" sticker on every receptacle that lost power.
- Press the test button (then reset button) every month to assure proper operation. In case the life- end indicator (Red LED) is off the GFCI will still provide ground fault protection.
- The GFCI includes an end-of-life monitoring function. When a GFCI receptacle is incapable of passing its internal test function (it can no longer provide ground fault protection), one of the following alarm indications will be present:
  - When the GFCI reaches the end of its' life the red indicator will turn on. The GFCI must be replaced.
  - If there is no power output the GFCI has reached the end of its' life. The GFCI must be replaced.

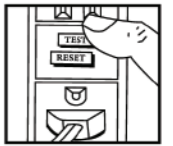
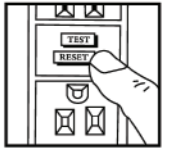

**TROUBLESHOOTING**

Turn the power off and check the wire connections against the appropriate wiring diagram in step 7A or 7B. Make sure that there are no loose wires or loose connections. Also, it is possible that you reversed the line and load connections if the GFCI can not be reset and there is no power at the receptacle. Start the test from the beginning of step 8 if you rewired any connections to the GFCI. The GFCI includes an end of life monitoring function. When a GFCI receptacle is incapable of passing its internal test function (it can no longer provide ground fault protection) one of the following alarm indications will be present: When the GFCI reaches the end of its' life the red indicator will turn on. The GFCI must be replaced. If there is no power output the GFCI has reached the end of its' life. The GFCI must be replaced.

15A, 120V, 60Hz  
20A, 120V, 60Hz